

Product data sheet

Specifications



TeSys F contactor - 3P (3 NO) - AC-3 - <= 440 V 630 A - coil 220 V AC

LC1F630M7

! To be discontinued on: 31 December 2023

! To be discontinued

Main

Range	TeSys
Range of product	TeSys F
Product or component type	Contactor
Device short name	LC1F
Contactor application	Resistive load Motor control
Utilisation category	AC-3 AC-1 AC-4
Poles description	3P
[Ue] rated operational voltage	<= 1000 V AC 50/60 Hz <= 460 V DC
[Uc] control circuit voltage	220 V AC 40...400 Hz
[Ie] rated operational current	1000 A (at <40 °C) at <= 440 V AC AC-1 630 A (at <55 °C) at <= 440 V AC AC-3

Complementary

[Uimp] rated impulse withstand voltage	8 kV
[Ith] conventional free air thermal current	1000 A (at 40 °C) 1250 A
Rated breaking capacity	5040 A conforming to IEC 60947-4-1
[Icw] rated short-time withstand current	5050 A 40 °C - 10 s 4400 A 40 °C - 30 s 3400 A 40 °C - 1 min 2200 A 40 °C - 3 min 1600 A 40 °C - 10 min
Associated fuse rating	1000 A gG at <= 440 V 630 A aM at <= 440 V
Average impedance	0.12 mOhm - Ith 1000 A 50 Hz
[Ui] rated insulation voltage	1000 V conforming to IEC 60947-4-1 1500 V conforming to VDE 0110 group C
Power dissipation per pole	120 W AC-1 48 W AC-3
Overvoltage category	III
Power pole contact composition	3 NO

Motor power kW	335 kW at 380...400 V AC 50/60 Hz (AC-3) 375 kW at 415 V AC 50/60 Hz (AC-3) 400 kW at 440 V AC 50/60 Hz (AC-3) 400 kW at 500 V AC 50/60 Hz (AC-3) 450 kW at 660...690 V AC 50/60 Hz (AC-3) 450 kW at 1000 V AC 50/60 Hz (AC-3) 200 kW at 220...230 V AC 50/60 Hz (AC-3) 100 kW at 400 V AC 50/60 Hz (AC-4)
Control circuit voltage limits	Operational: 0.85...1.1 Uc 40...400 Hz (at 55 °C) Drop-out: 0.25...0.5 Uc 40...400 Hz (at 55 °C)
Mechanical durability	5 Mcycles
Inrush power in VA	1650 VA, 40...400 Hz cos phi 0.9 (at 20 °C)
Hold-in power consumption in VA	22 VA, 40...400 Hz cos phi 0.9 (at 20 °C)
Maximum operating rate	1200 cyc/h 55 °C
Operating time	40...80 ms closing 100...200 ms opening
Connections - terminals	Control circuit: screw clamp terminals 1 cable(s) 1...4 mm ² flexible without cable end Control circuit: screw clamp terminals 2 cable(s) 1...4 mm ² flexible without cable end Control circuit: screw clamp terminals 1 cable(s) 1...4 mm ² flexible with cable end Control circuit: screw clamp terminals 2 cable(s) 1...2.5 mm ² flexible with cable end Control circuit: screw clamp terminals 1 cable(s) 1...4 mm ² solid without cable end Control circuit: screw clamp terminals 2 cable(s) 1...4 mm ² solid without cable end Power circuit: bar 2 cable(s) - busbar cross section: 60 x 5 mm Power circuit: bolted connection
Tightening torque	Control circuit: 1.2 N.m Power circuit: 58 N.m
Mounting support	Plate
Heat dissipation	20 W
Motor power range	250...500 kW at 380...440 V 3 phases 110...220 kW at 200...240 V 3 phases 250...500 kW at 480...500 V 3 phases
Motor starter type	Direct on-line contactor
Contactor coil voltage	220 V AC standard
Standards	EN 60947-1 IEC 60947-4-1 JIS C8201-4-1 IEC 60947-1 EN 60947-4-1
Product certifications	LROS (Lloyds register of shipping) CB UL RMRoS CSA ABS BV DNV RINA UKCA
Compatibility code	LC1F
Control circuit type	AC at 40...400 Hz
Environment	
IP degree of protection	IP20 front face with shrouds conforming to IEC 60529 IP20 front face with shrouds conforming to VDE 0106
Protective treatment	TH
Ambient air temperature for operation	-5...55 °C
Ambient air temperature for storage	-60...80 °C
Permissible ambient air temperature around the device	-40...70 °C
Height	304 mm

Width	309 mm
Depth	255 mm
Operating altitude	3000 m without derating
Net weight	18.6 kg

Packing Units

Unit Type of Package 1	PCE
Number of Units in Package 1	1
Package 1 Height	29.46 cm
Package 1 Width	36.83 cm
Package 1 Length	46.99 cm
Package 1 Weight	18.78 kg
Unit Type of Package 2	P06
Number of Units in Package 2	4
Package 2 Height	80 cm
Package 2 Width	80 cm
Package 2 Length	60 cm
Package 2 Weight	82.232 kg

Offer Sustainability

Sustainable offer status	Green Premium product
REACH Regulation	REACH Declaration
EU RoHS Directive	Compliant EU RoHS Declaration
Mercury free	Yes
China RoHS Regulation	China RoHS declaration Product out of China RoHS scope. Substance declaration for your information
RoHS exemption information	Yes
Environmental Disclosure	Product Environmental Profile
Circularity Profile	End of Life Information
WEEE	The product must be disposed on European Union markets following specific waste collection and never end up in rubbish bins
California proposition 65	WARNING: This product can expose you to chemicals including: Lead and lead compounds, which is known to the State of California to cause cancer and birth defects or other reproductive harm. For more information go to www.P65Warnings.ca.gov

Contractual warranty

Warranty	18 months
----------	-----------

Dimensions and Drawings

LC1 F630 and F800

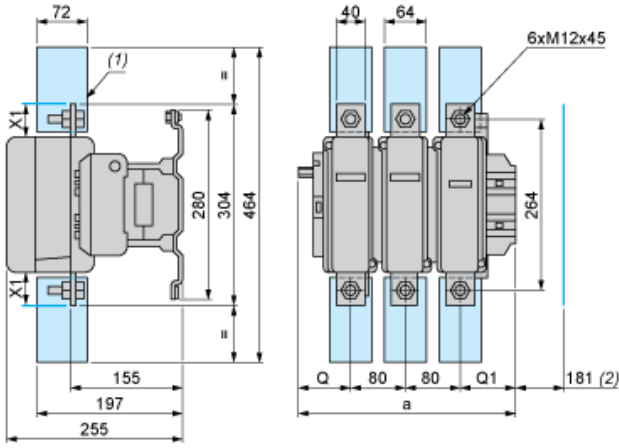

- (1) Power terminal protection shroud.
- (2) Minimum distance required for coil removal.

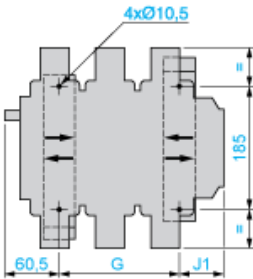

NOTE: X1 (mm) = Minimum electrical clearance according to operating voltage and breaking capacity.

LC1		a	G supplied	G min.	G max.	J1	Q	Q1
F630	2P	309	180	100	195	68.5	102	127
F630, F800	3P	309	180	100	195	68.5	60	89
F630	4P	389	240	150	275	88.5	60	89
Voltage		200...500 V	690...1000 V	200...690 V	1000 V			
LC1 F630		20	30	-				
LC1 F800		-	-	10			20	

TeSys F reversing contactors and changeover contactor pairs Vertically mounted

NOTE: For customer assembly, with mechanical interlock (MI) LA9 F, fixing recommended on AM1 EC uprights (please consult your Regional Sales Office). 2 x LC1 identical or different ratings (LC1 F115 to F630 and F800).

Assembly A

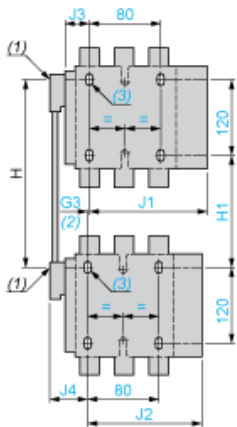

- (1) Mechanical interlock shaft.
- (2) For assembly of contactors of different ratings only.
- (3) 4 x Ø6.5 for LC1 F115 to F225.

Assembly A⁽⁷⁾ - Mechanical interlock reference

	G3 3P	G3 4P	H min.	H max.	H1 min.	H1 max.	J1 3P	J1 4P
LA9 FF4F	0	0	200	310	80	190	137	155.5
LA9 FG4F	3	4	210	300	90	180	139.5	159.5

	G3 3P	G3 4P	H min.	H max.	H1 min.	H1 max.	J1 3P	J1 4P
LA9 FG4G	0	0	220	310	100	190	139.5	159.5

	J2 3P	J2 4P	J3 3P	J3 4P	J4 3P	J4 4P
LA9 FF4F	137	155.5	48.5	67	48.5	67
LA9 FG4F	137	155.5	53	73	54	69
LA9 FG4G	139.5	159.5	53	73	53	73

Assembly B

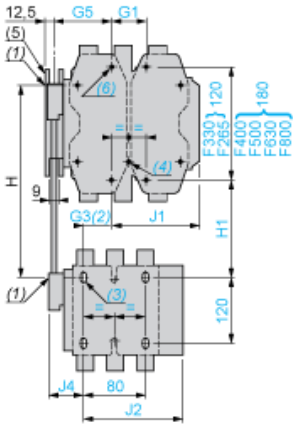

- (4) 4 x Ø6.5 for LC1 F265.
- (5) Mechanical interlock guide bracket.

Assembly B⁽⁷⁾ - Mechanical interlock reference

	G1 3P	G1 4P	G3 3P	G3 4P	G5 3P	G5 4P	H min.	H max.
LA9 FH4F	96	96	21	27	60	83	240	380
LA9 FJ4F	80	80	45	26	83	83	250	380
LA9 FK4F	80	140	45	26	83	83	270	380
LA9 FL4F	180	240	35	17	74	74	310	380
LA9 FH4G	96	96	19	23	60	83	250	380
LA9 FJ4G	80	80	42	22	83	83	250	380
LA9 FK4G	80	140	42	22	83	83	270	380
LA9 FL4G	180	240	33	13	74	74	310	380

	H1 min.	H1 max.	J1 3P	J1 4P	J2 3P	J2 4P	J4 3P	J4 4P
LA9 FH4F	110	250	157.5	181.5	137	155.5	48.5	67
LA9 FJ4F	80	210	144.5	192.5	137	155.5	48.5	67
LA9 FK4F	100	210	164.5	219.5	137	155.5	48.5	67
LA9 FL4F	140	210	248.5	328.5	137	155.5	48.5	67
LA9 FH4G	120	250	157.5	181.5	139.5	159.5	53	73
LA9 FJ4G	90	220	144.5	192.5	139.5	159.5	53	73
LA9 FK4G	110	220	164.5	219.5	139.5	159.5	53	73
LA9 FL4G	150	220	248.5	328.5	139.5	159.5	53	73

Assembly C

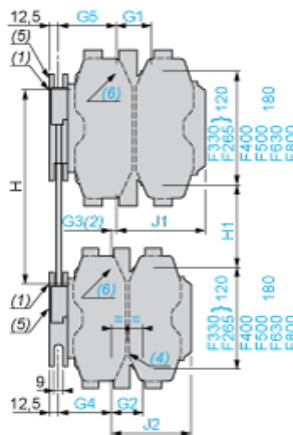

- (6) 4 x Ø8.5 for LC1 F400, F500 or 4 x Ø10.5 for LC1 F630 and F800.



(7) Only 3P for F800.

(8) In this case, G4 is greater than G5.

Assembly C⁽⁷⁾

	G1 3P	G1 4P	G2 3P	G2 4P	G3 3P	G3 4P	G4 3P	G4 4P	G5 3P	G5 4P
LA9 FH4H	96	96	96	96	0	0	60	83	60	83
LA9 FJ4H	80	80	96	96	23	0	60	83	83	83
LA9 FK4H	80	140	96	96	23	0	60	83	83	83
LA9 FL4H	180	240	96	96	14	g ⁽⁸⁾	60	83	74	74
LA9 FJ4J	80	80	80	80	0	0	83	83	83	83
LA9 FK4J	80	140	80	80	0	0	83	83	83	83
LA9 FL4J	180	240	80	80	g ⁽⁸⁾	g ⁽⁸⁾	83	83	74	74
LA9 FK4K	80	140	80	140	0	0	83	83	83	83
LA9 FL4K	180	240	80	140	g ⁽⁸⁾	g ⁽⁸⁾	83	83	74	74
LA9 FL4L	180	240	180	240	0	0	74	74	74	74

	H min.	H max.	H1 min.	H1 max.	J1 3P	J1 4P	J2 3P	J2 4P
LA9 FH4H	250	380	130	260	157.5	181.5	157.5	181.5
LA9 FJ4H	260	380	110	230	144.5	192.5	157.5	181.5
LA9 FK4H	280	380	130	230	164.5	219.5	157.5	181.5
LA9 FL4H	330	380	170	220	248.5	328.5	157.5	181.5
LA9 FJ4J	260	380	60	200	144.5	192.5	144.5	192.5
LA9 FK4J	280	380	100	200	164.5	219.5	144.5	192.5
LA9 FL4J	325	380	140	195	248.5	329.5	144.5	192.5
LA9 FK4K	300	380	120	200	164.5	329.5	164.5	219.5
LA9 FL4K	345	380	160	195	248.5	328.5	164.5	219.5
LA9 FL4L	380	380	200	200	248.5	328.5	248.5	328.5

Connections and Schema

2, 3, and 4-pole Contactors

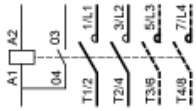

LC1 F115 to F630, F1250(coil LX1 F ~)

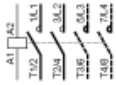

LC1 F115 to F630 , F1250 (coil LX4 F ≡)

LC1 F115 to F265 (coil LX9 F ~)

LC1 F800 (coil LX8 F ~ / ≡)

Recommended replacement(s)

LC1F630M7 is replaced by:

1x



High power contactor, TeSys Giga, 3 pole (3NO), AC-3 <=440V 630A, standard version, 100...250V wide band AC/DC coil

LC1G630KUEN
